

AS-09-WB

MIROMARK
ФАБРИКА МЕБЛІВ

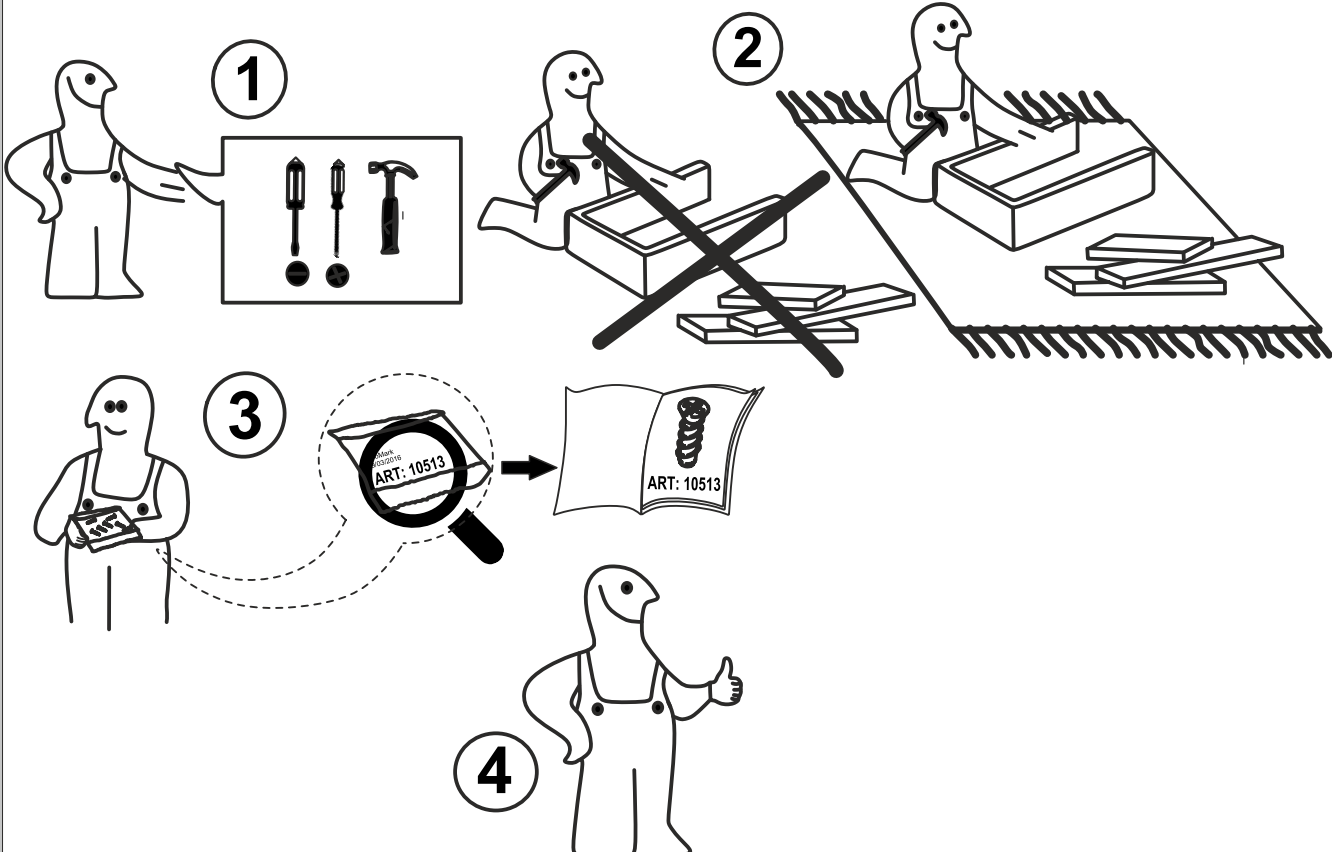

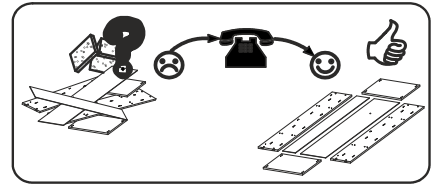
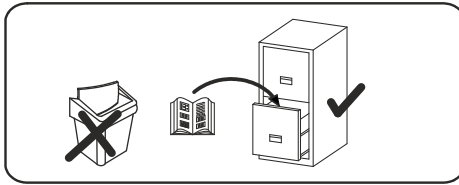
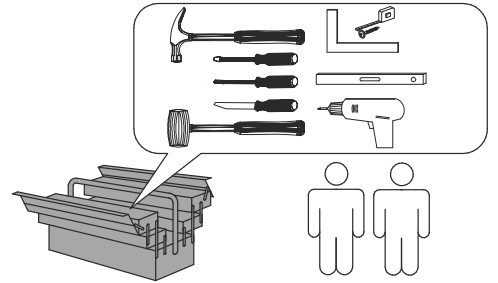
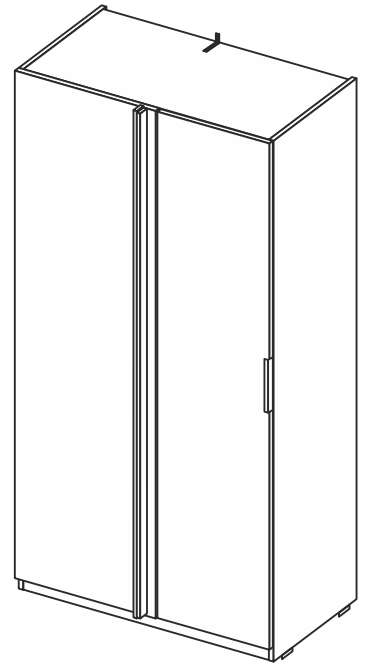
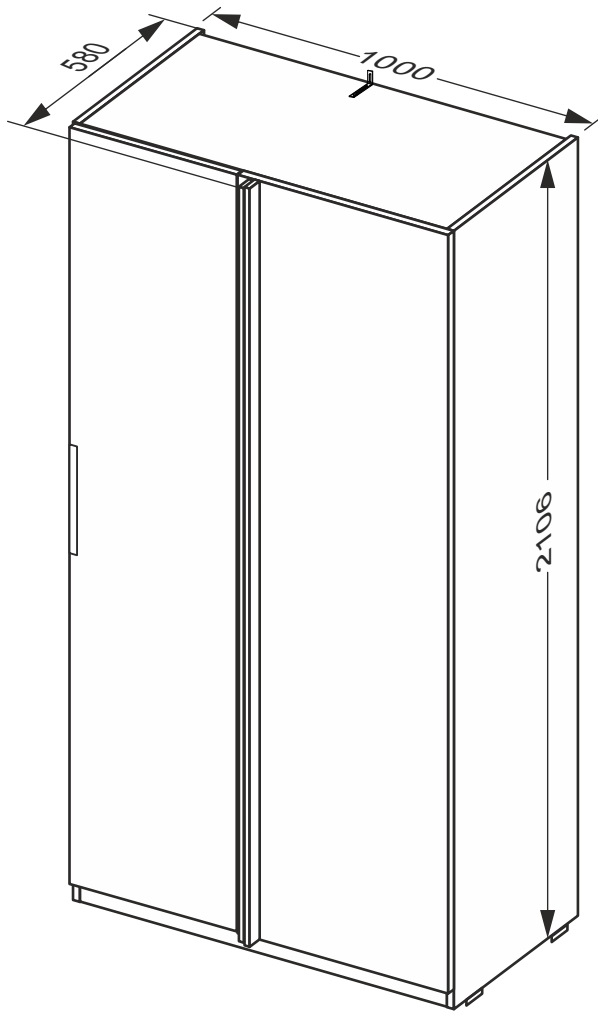
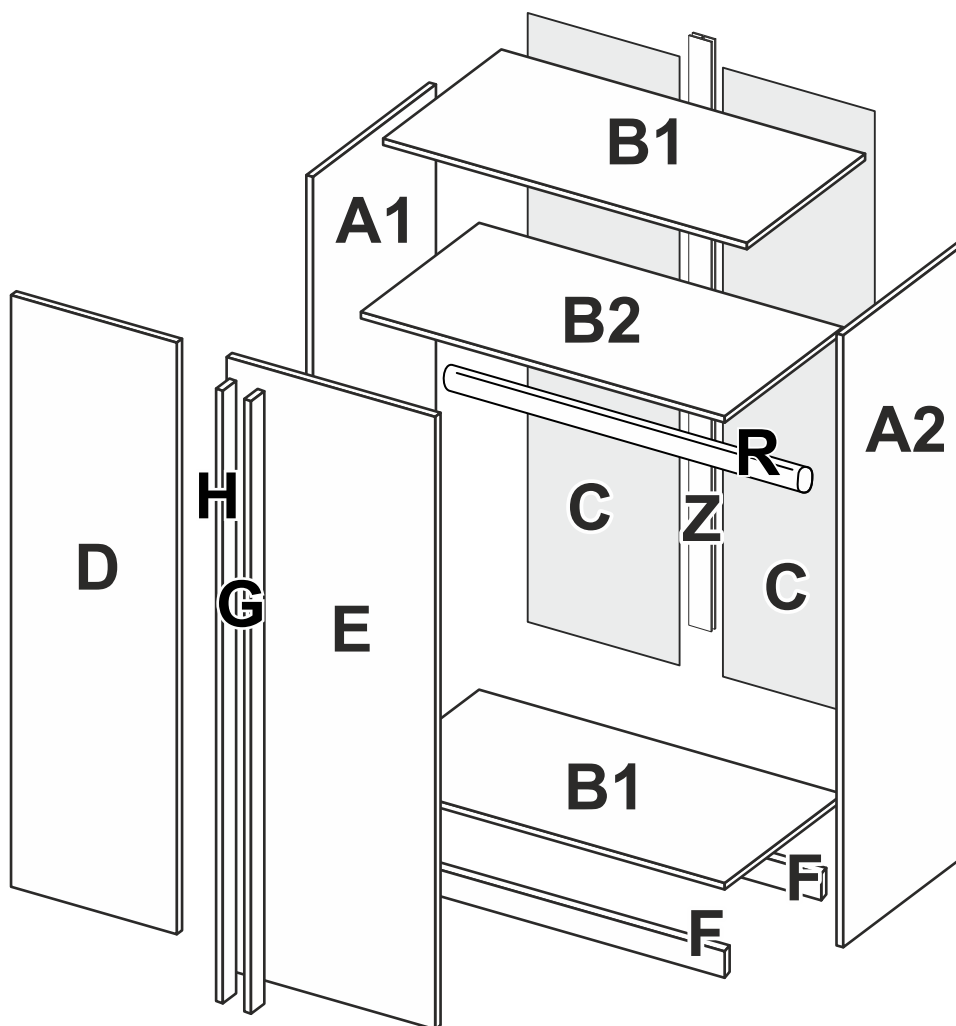

A1	- 2104x530 x 16	- x	1
A2	- 2104x530 x 16	- x	1
B1	- 968 x516 x 16	- x	2
B2	- 968 x516 x 16	- x	1
C	- 2054x490 x 3	- x	2
D	- 2050x444 x 16	- x	1
E	- 2104x550 x 18	- x	1
F	- 968 x 50 x 16	- x	2
G	- 2104x 34 x 16	- x	1
H	- 2050x 34 x 16	- x	1
R	-961MM	- x	1
Z	-2000MM	- x	1

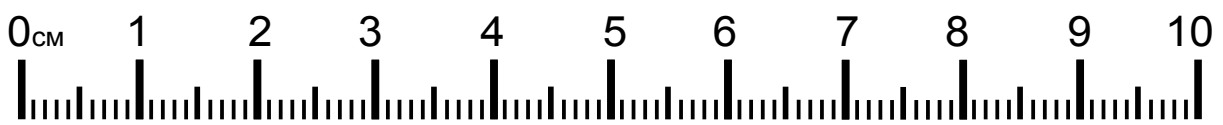
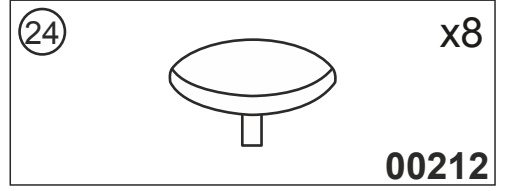
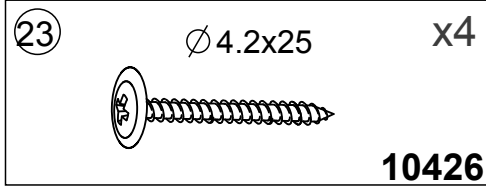
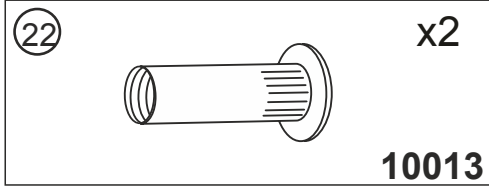
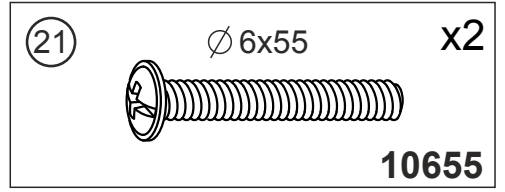
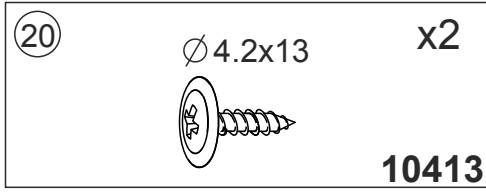
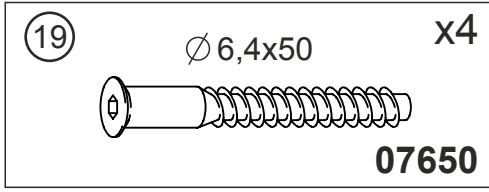
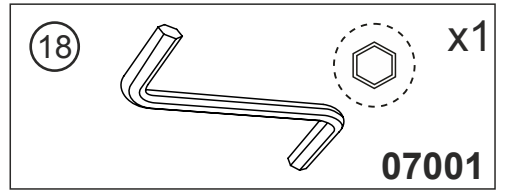
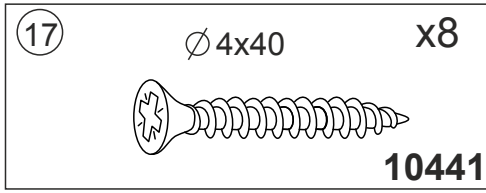
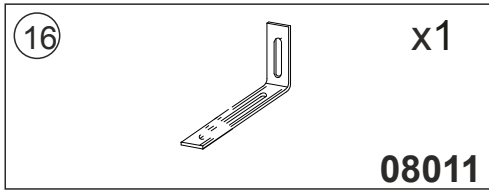
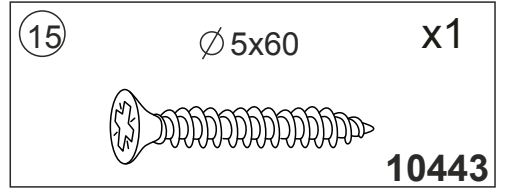
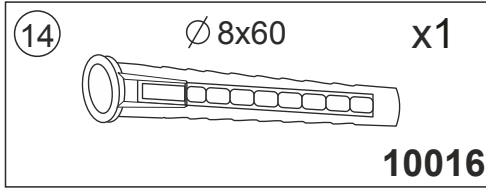
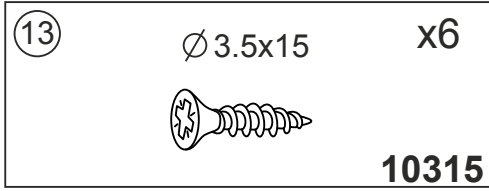
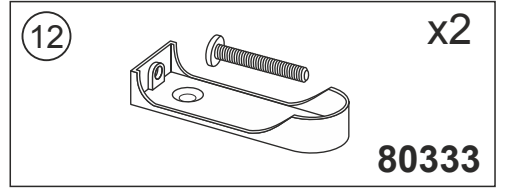
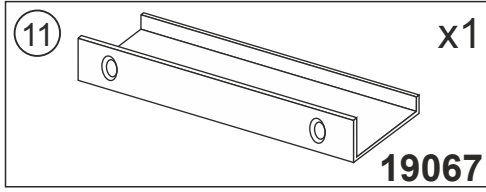
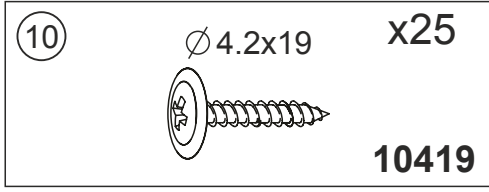
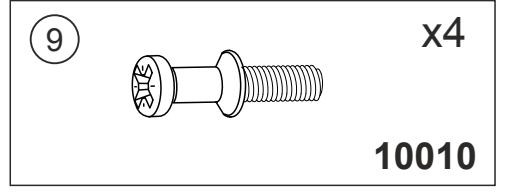
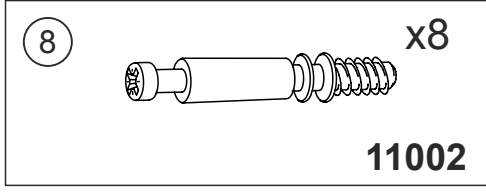
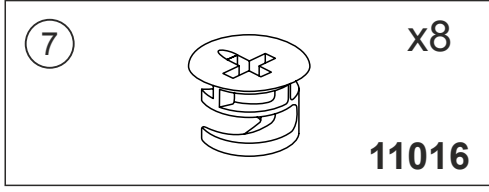
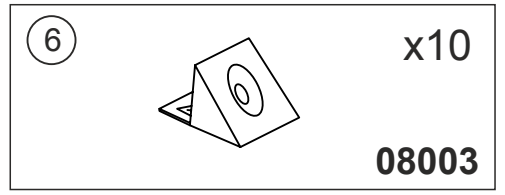
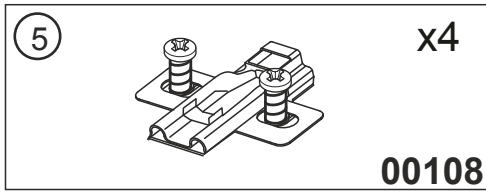
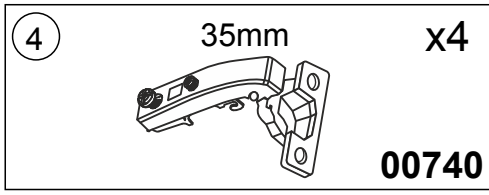
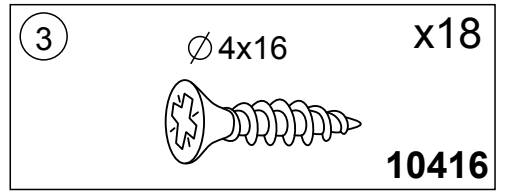
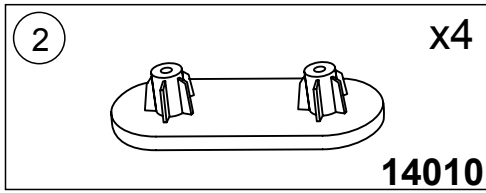
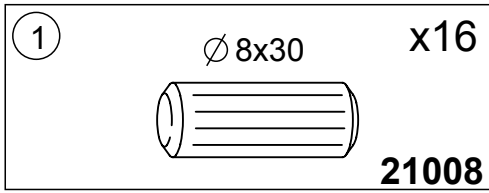

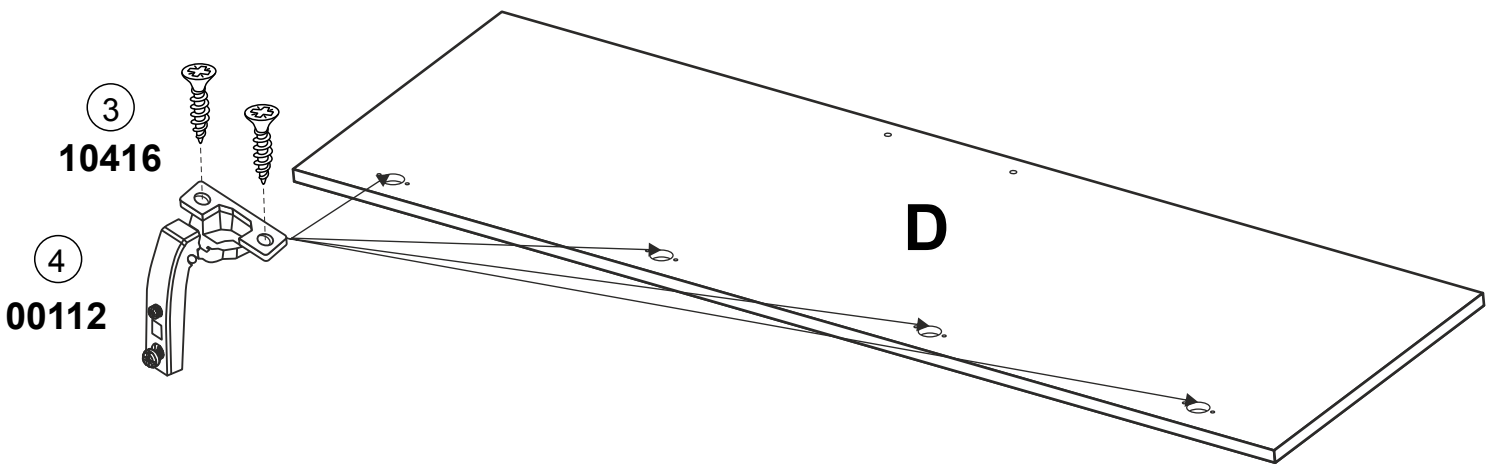
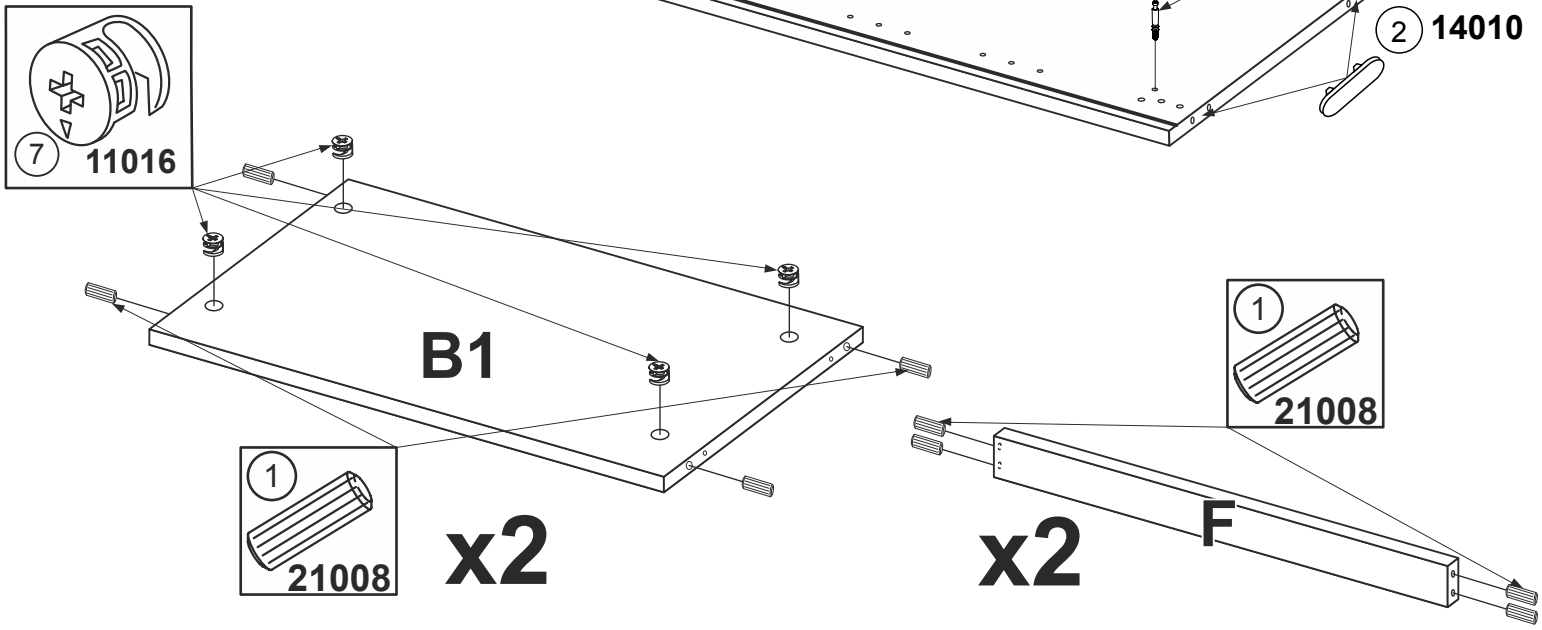
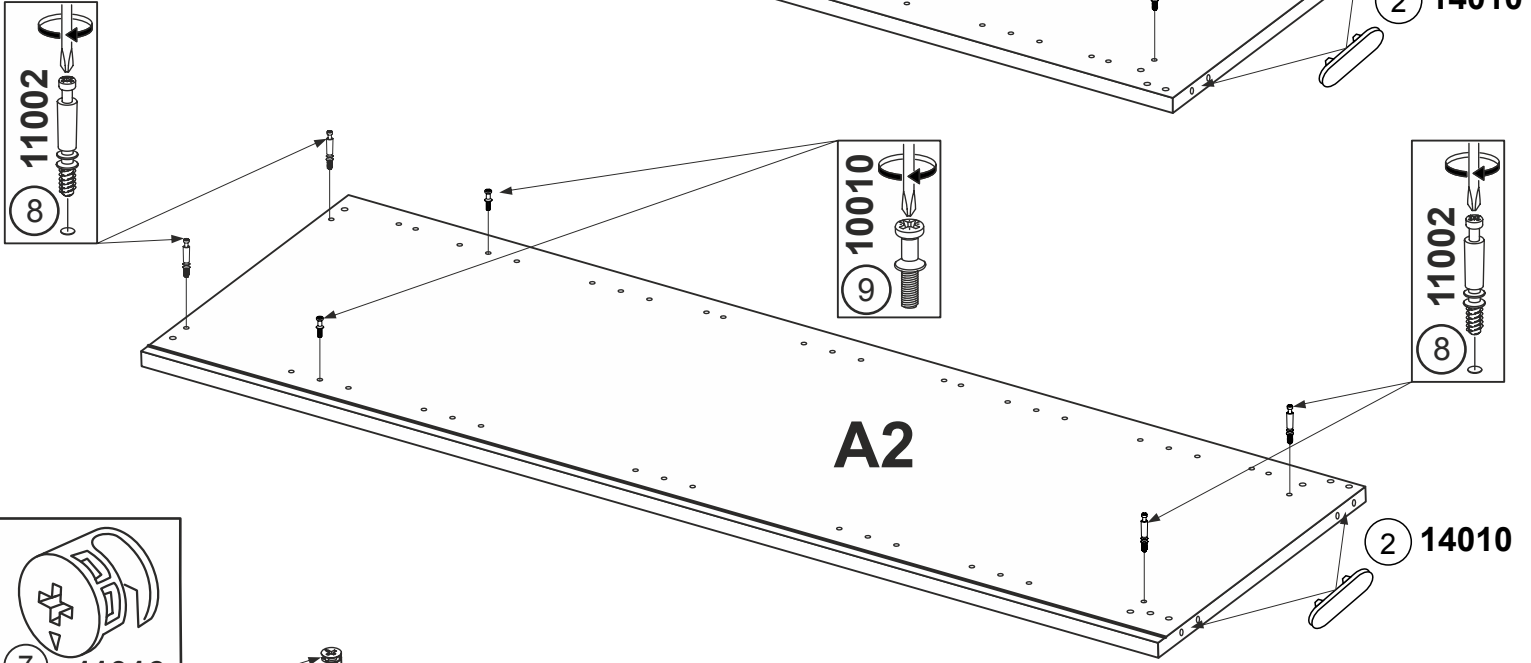
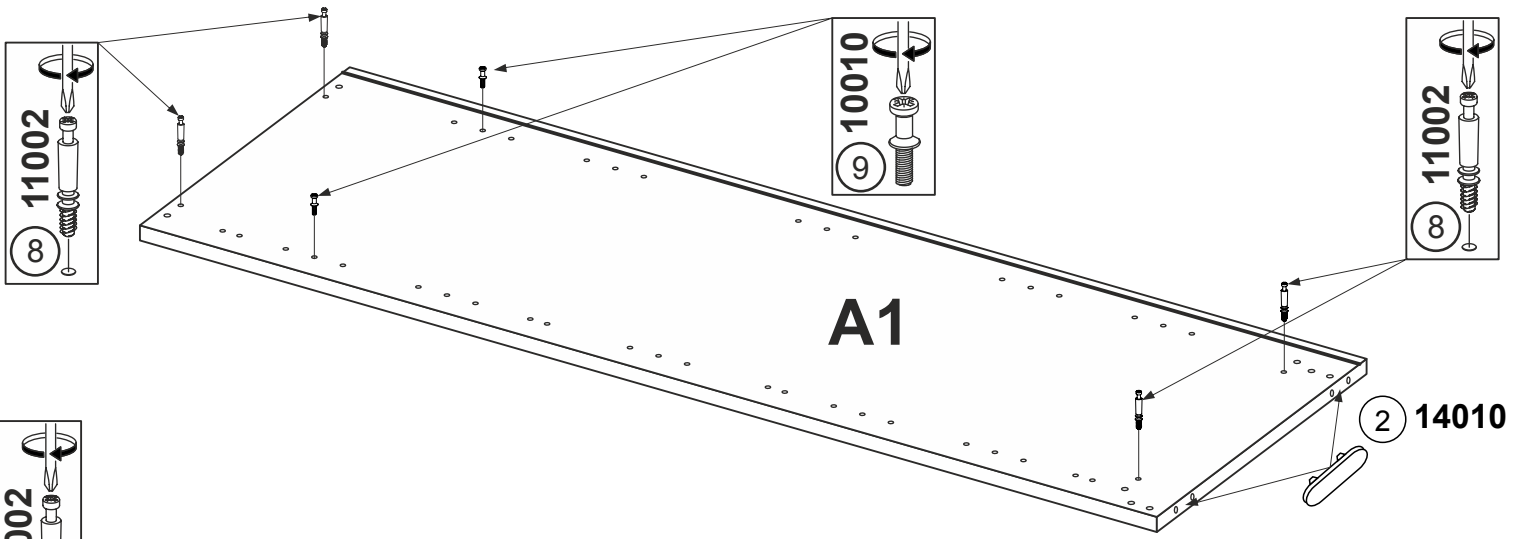

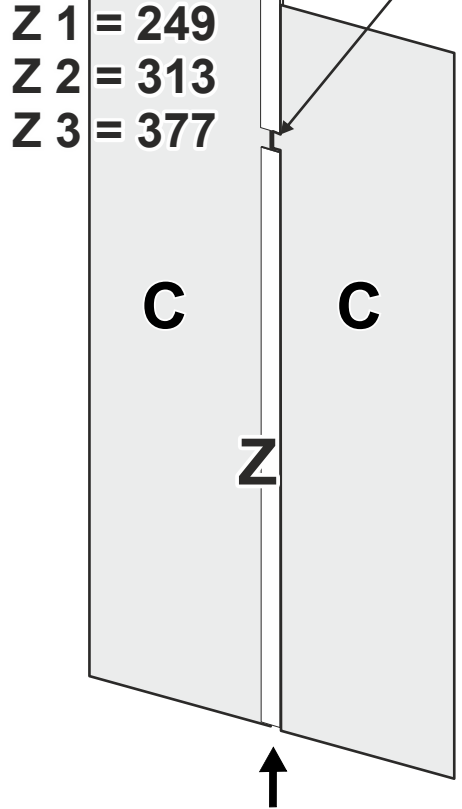
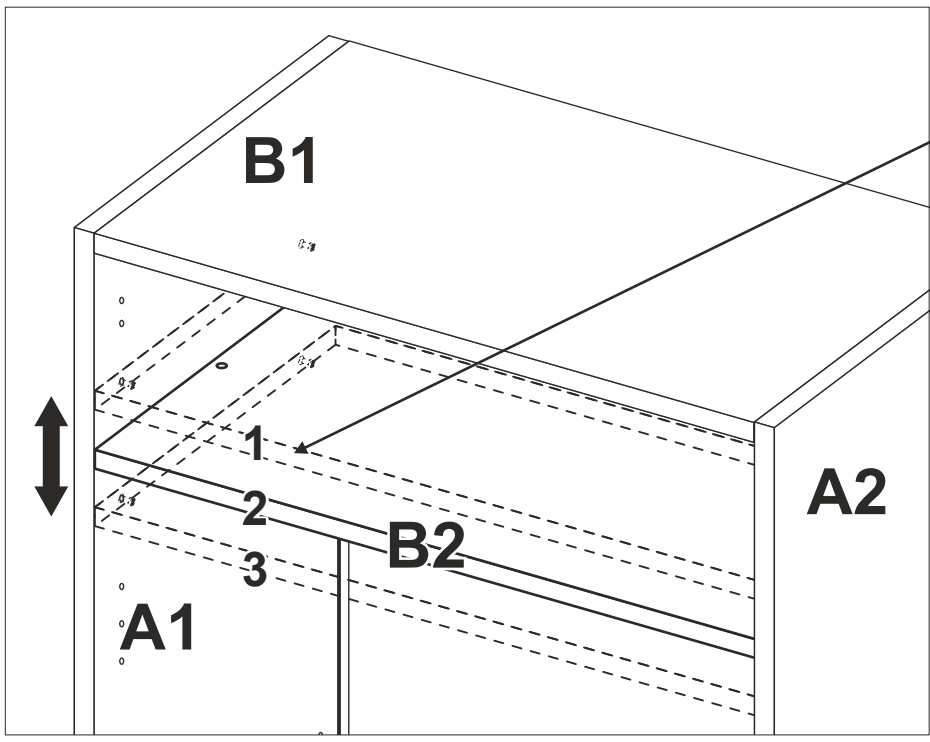
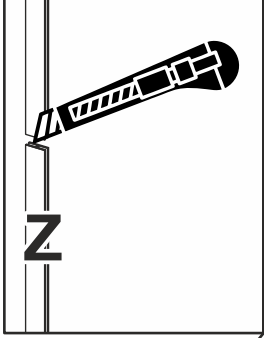
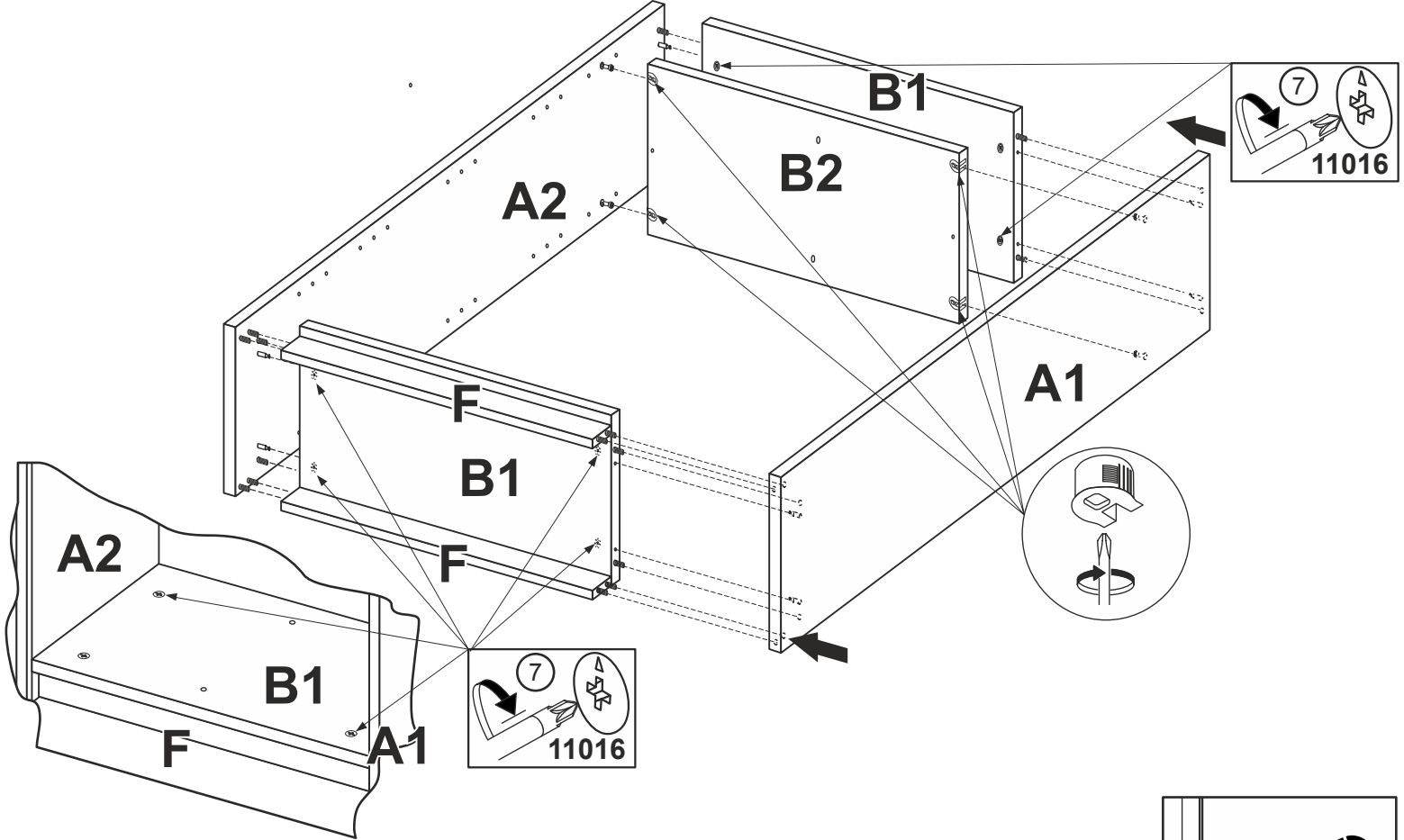

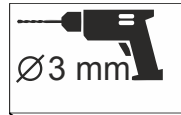
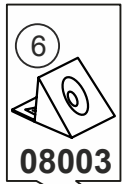
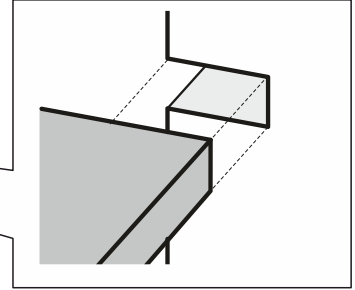
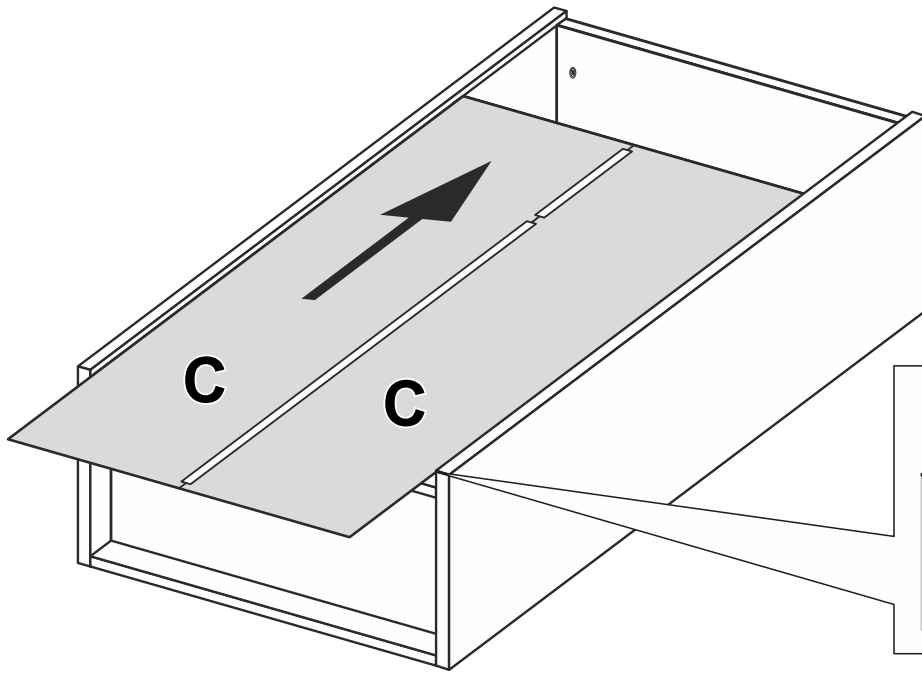

$a=b$

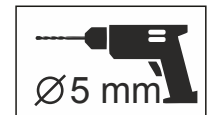
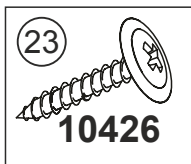
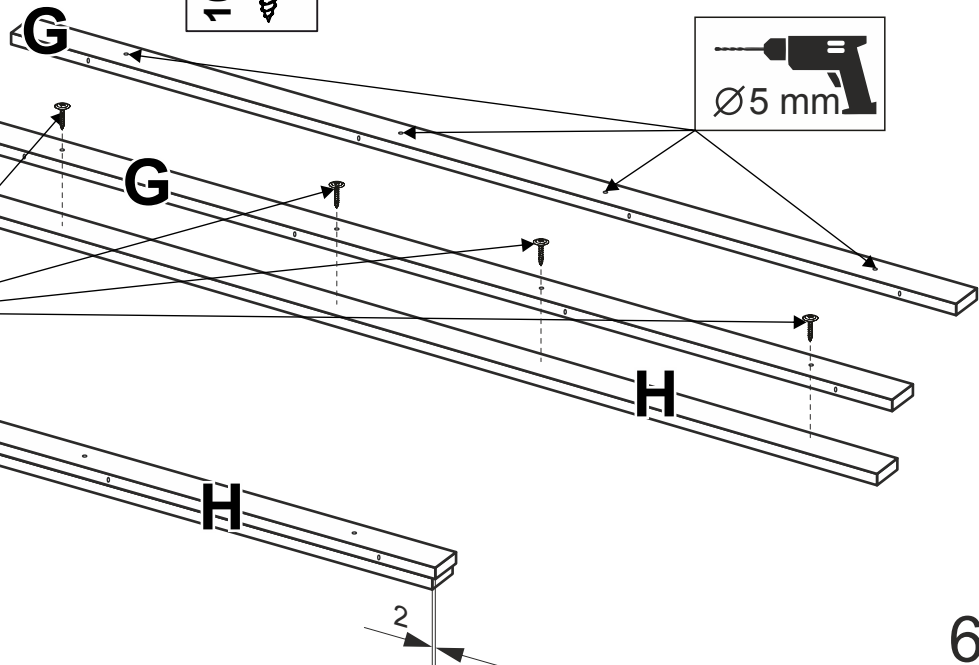
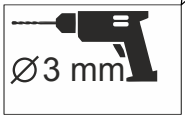
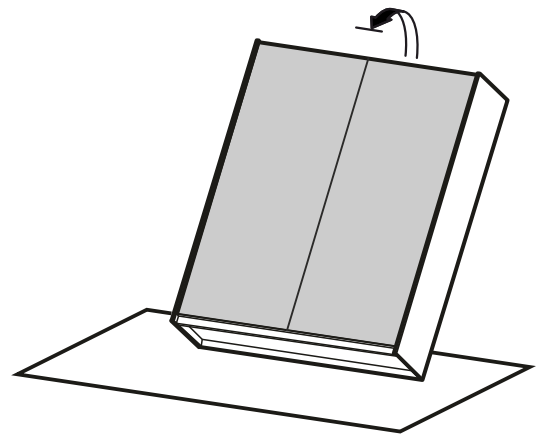
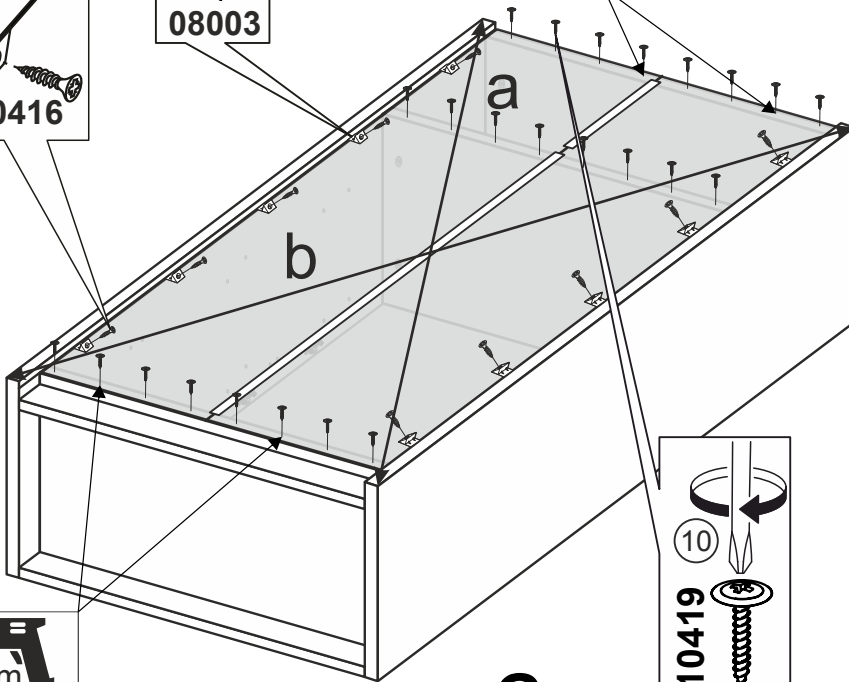
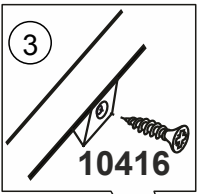

52

2

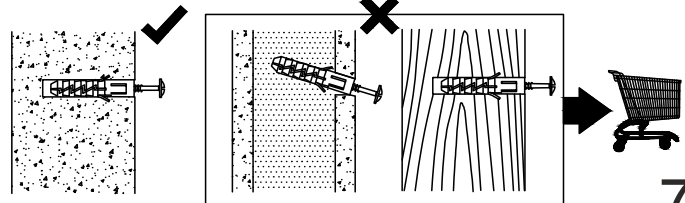
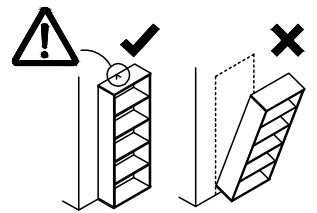
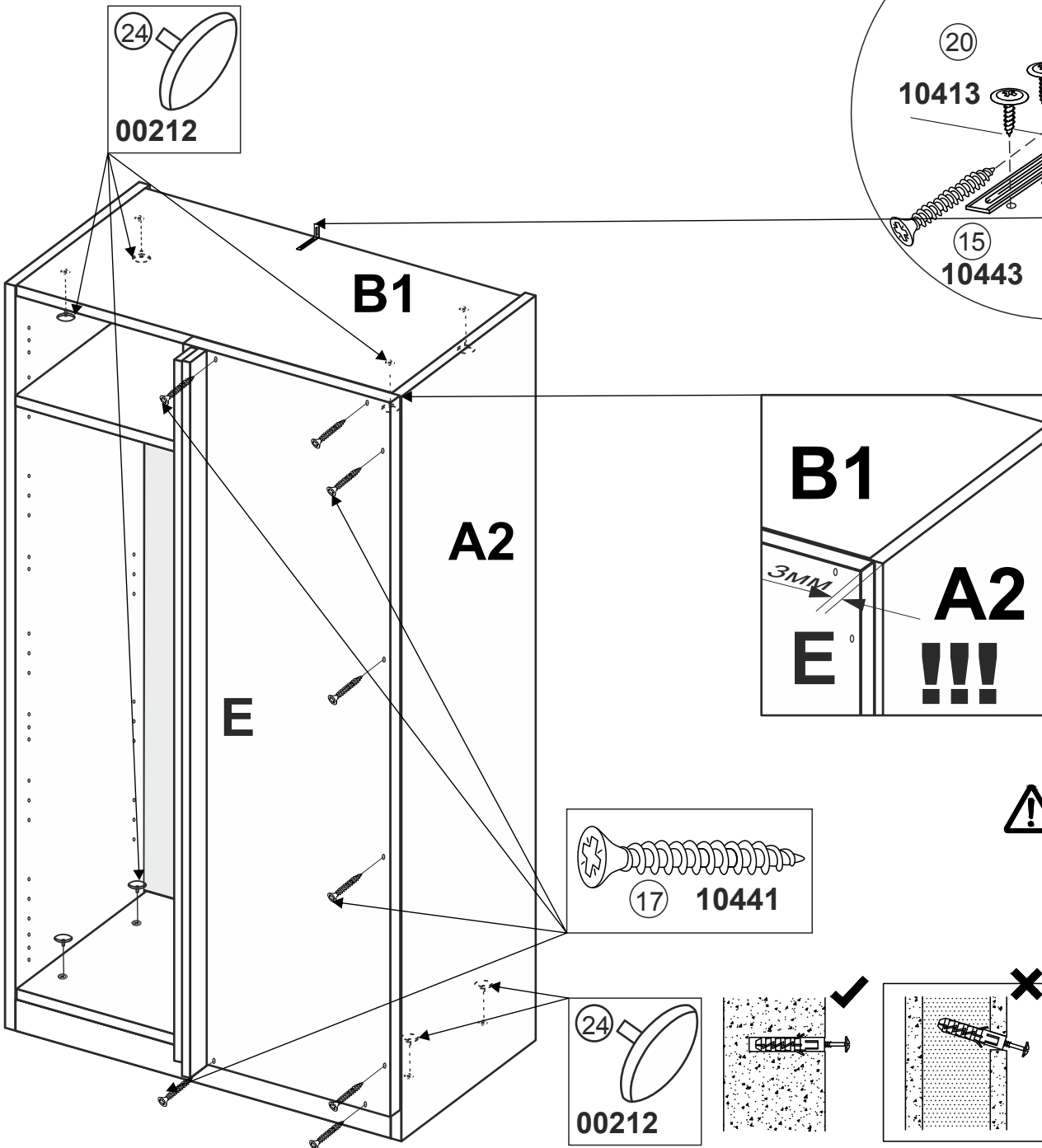
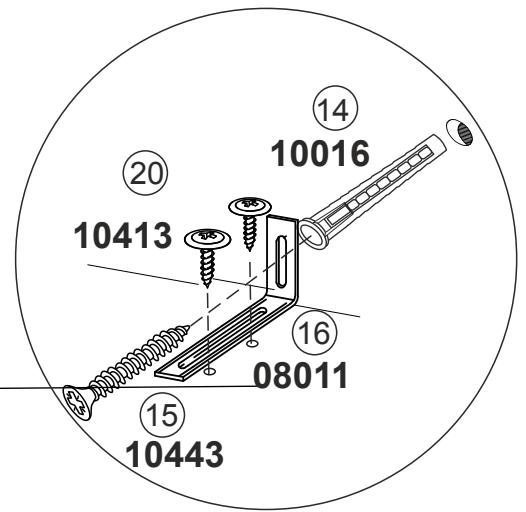
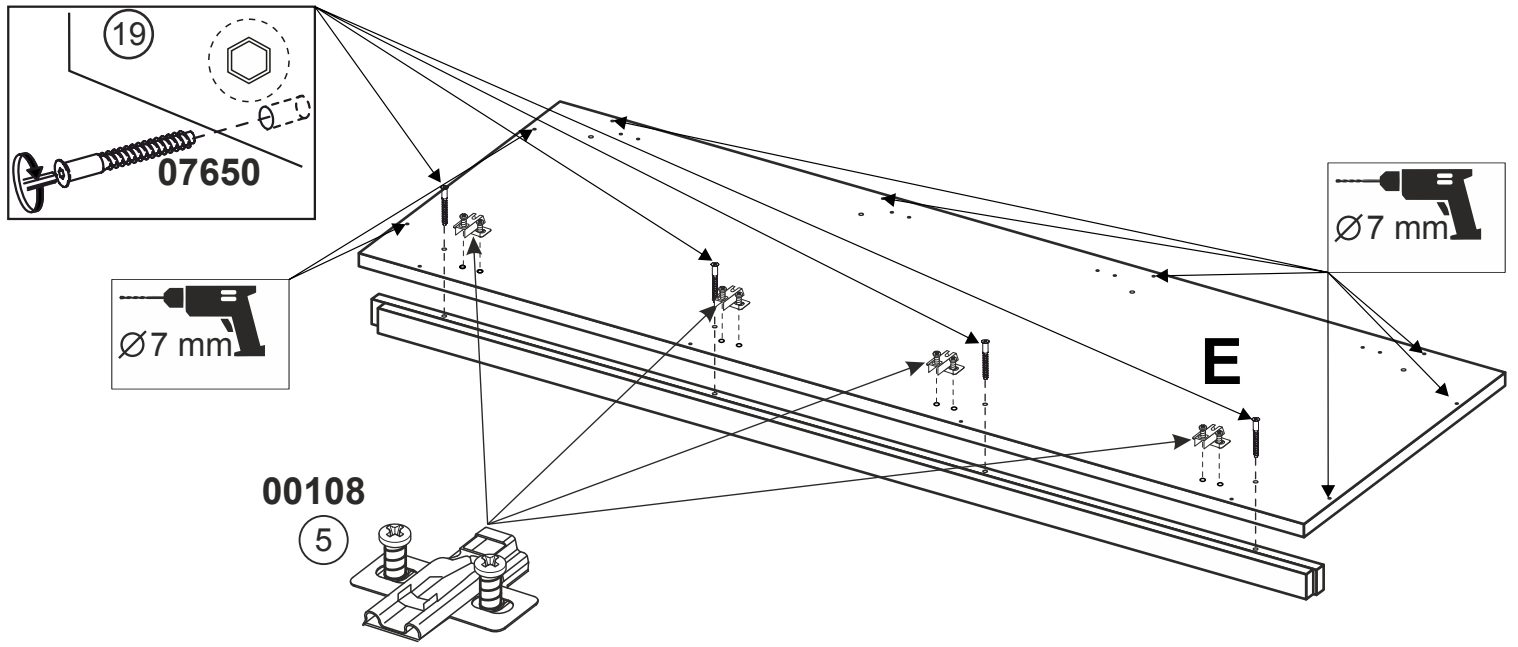

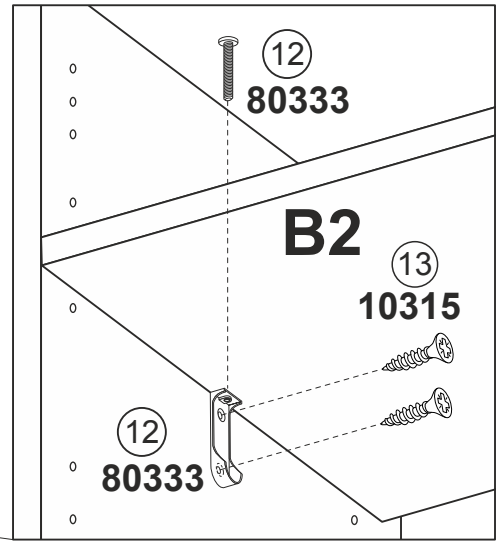
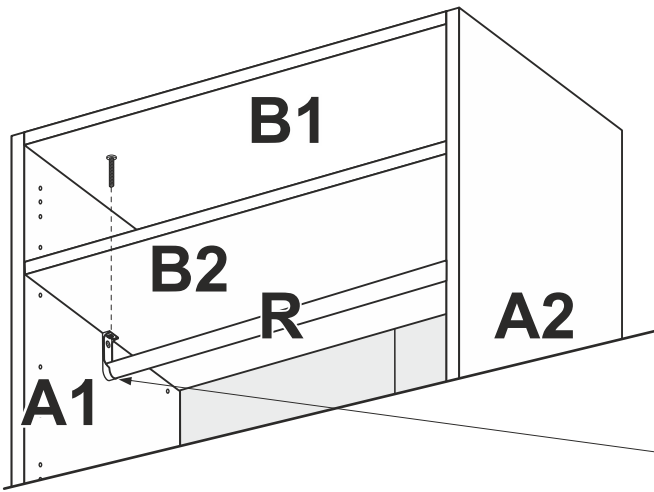

4
00740

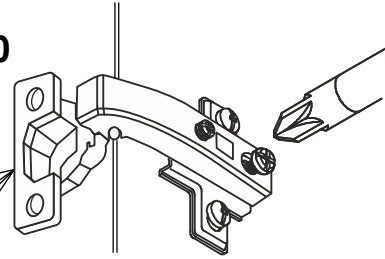

!!! Recommend !!!

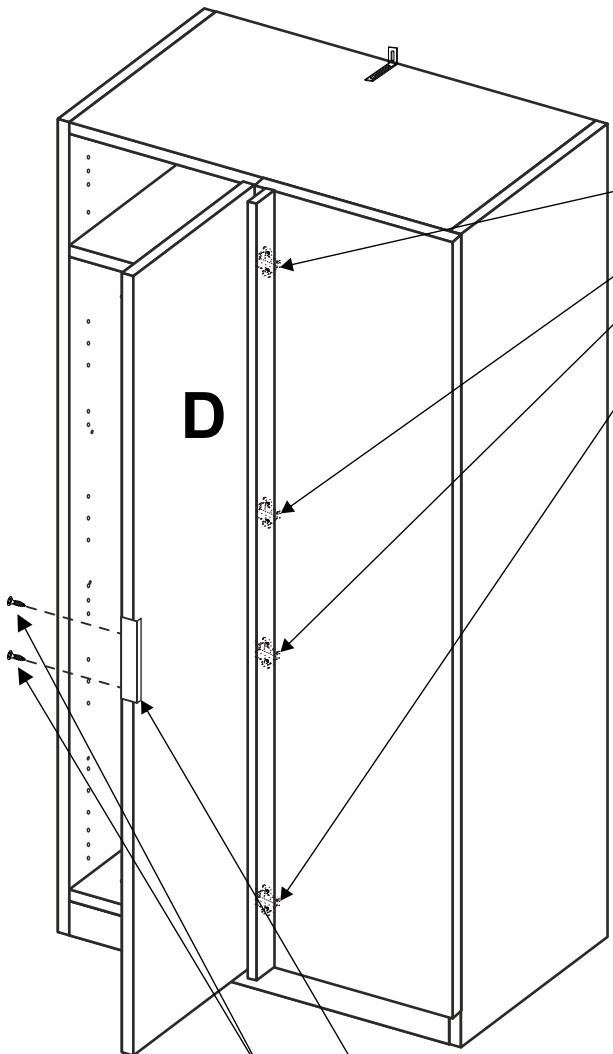

21
10655

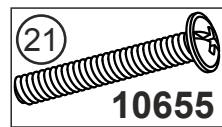

22
10013

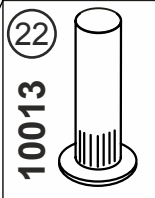

13
10315

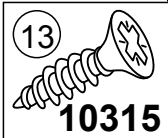

11
19067

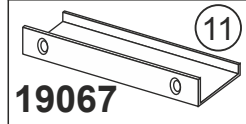

Ø8 mm

Diagram showing a drill bit used for panel installation.