

# TABLE

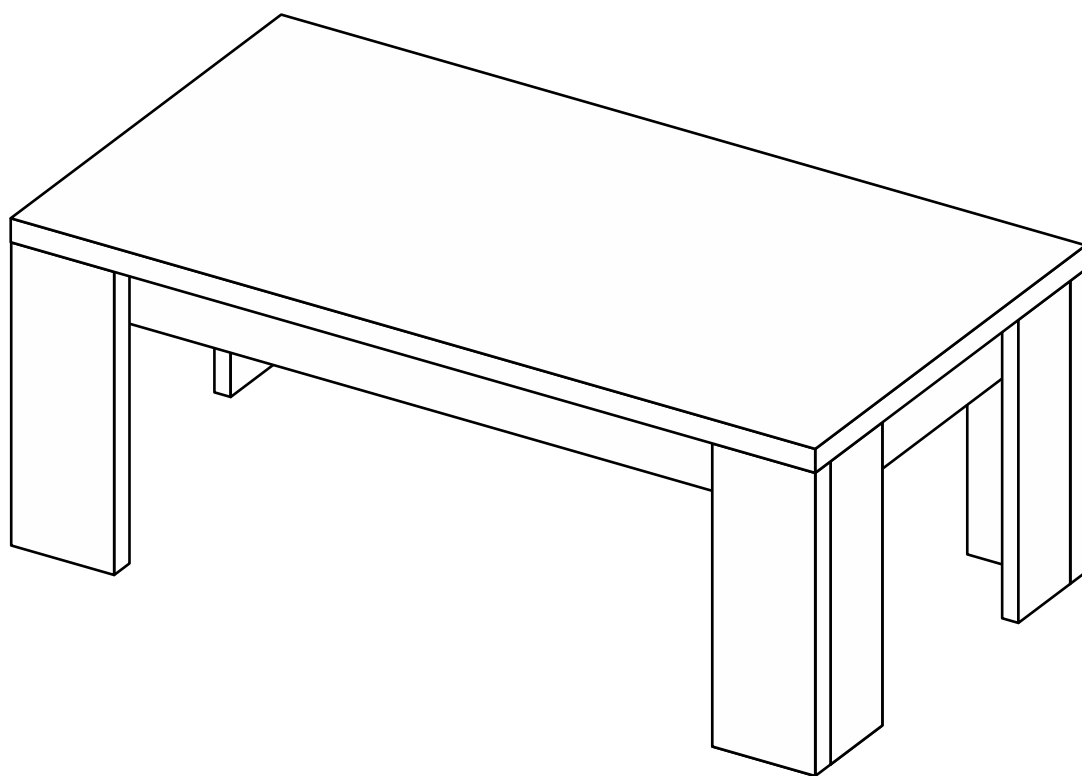

B1041  
B4041

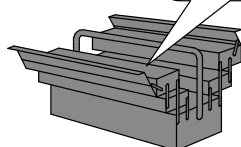
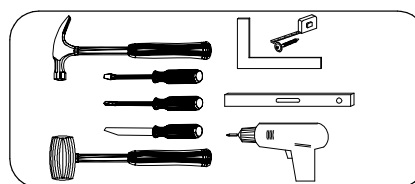
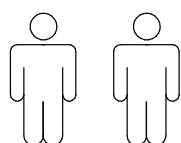

1

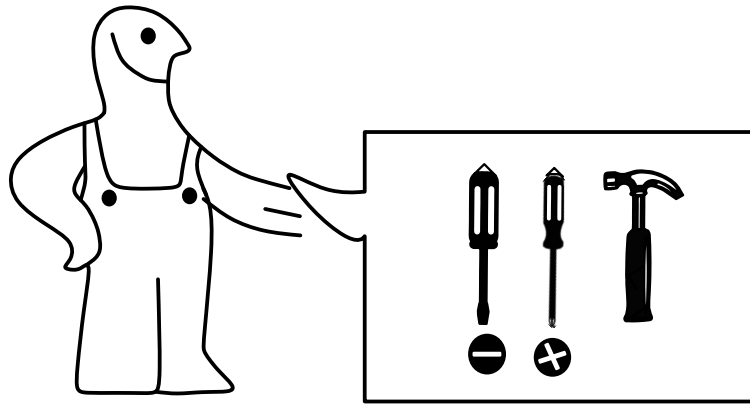

2

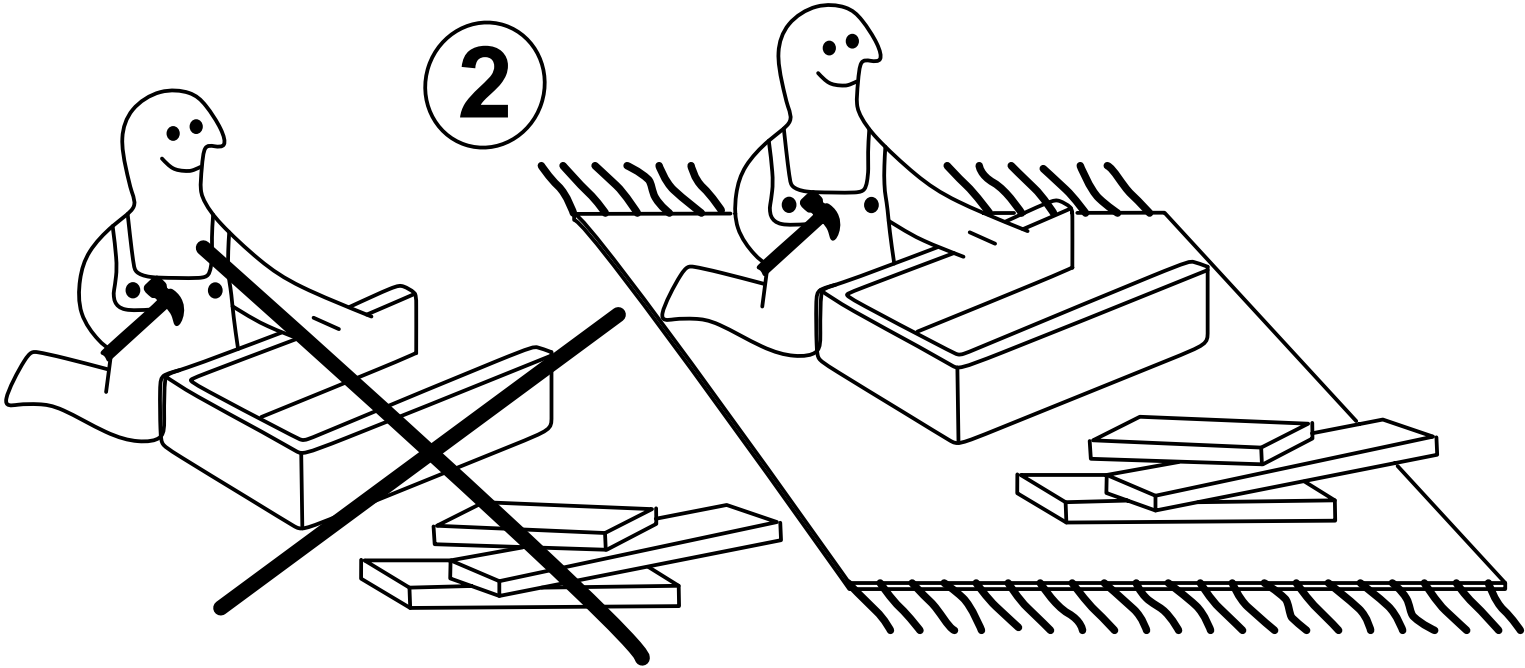

3

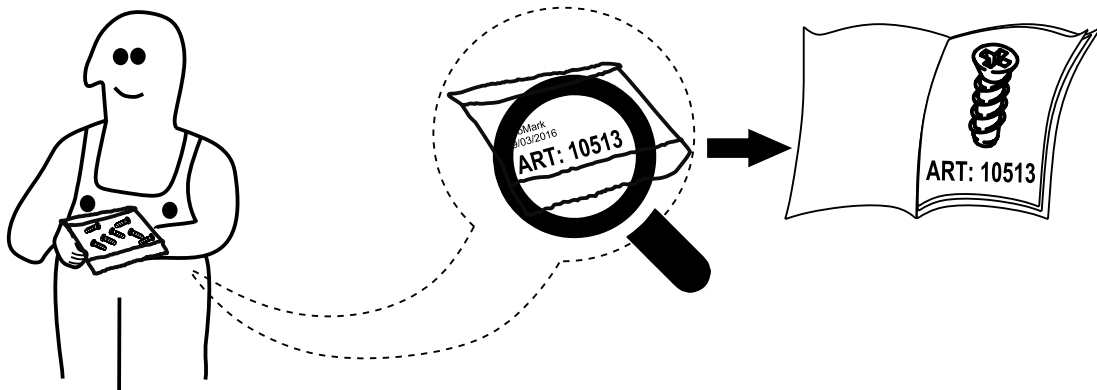

4

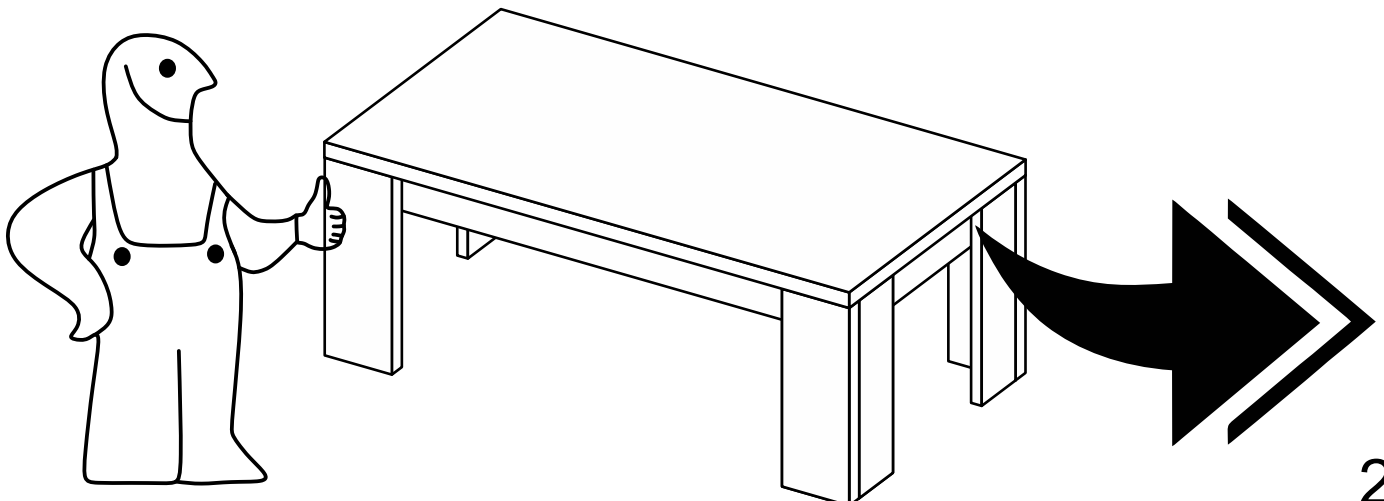

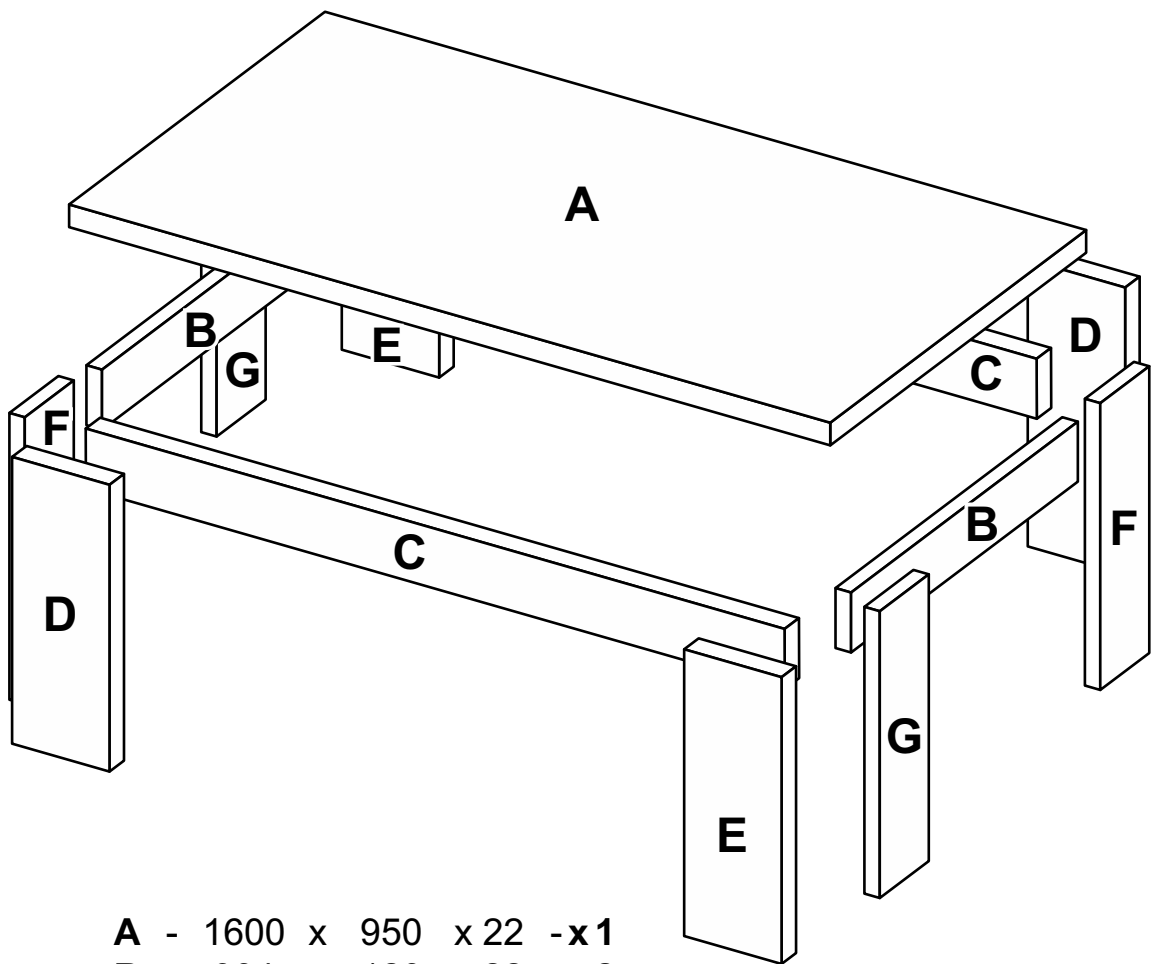
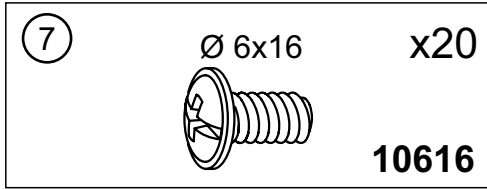
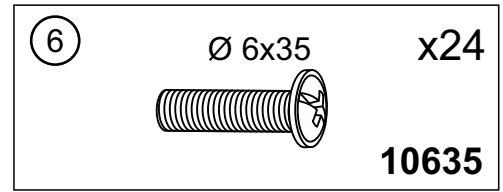
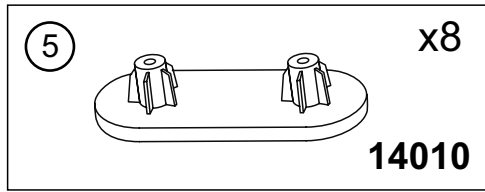
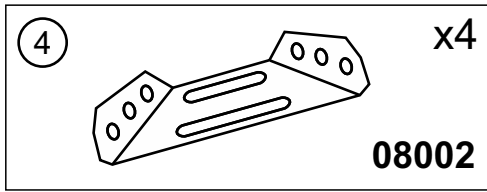
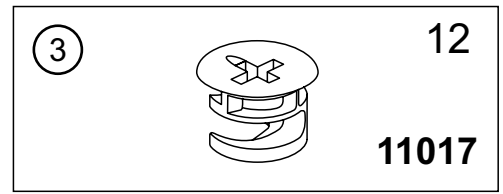
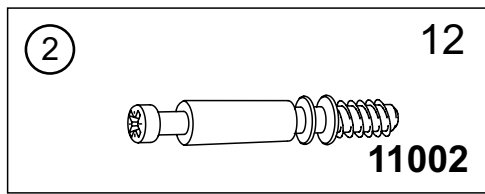
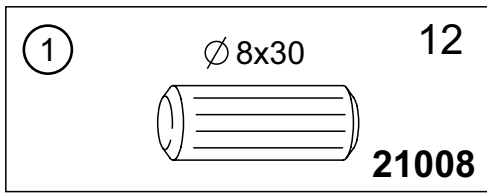

- A** - 1600 x 950 x 22 -x 1
- B** - 904 x 120 x 22 -x 2
- C** - 1510 x 120 x 22 -x 2
- D** - 738 x 150 x 22 -x 2
- E** - 738 x 150 x 22 -x 2
- F** - 738 x 128 x 22 -x 2
- G** - 738 x 128 x 22 -x 2

