

# WARDROBE

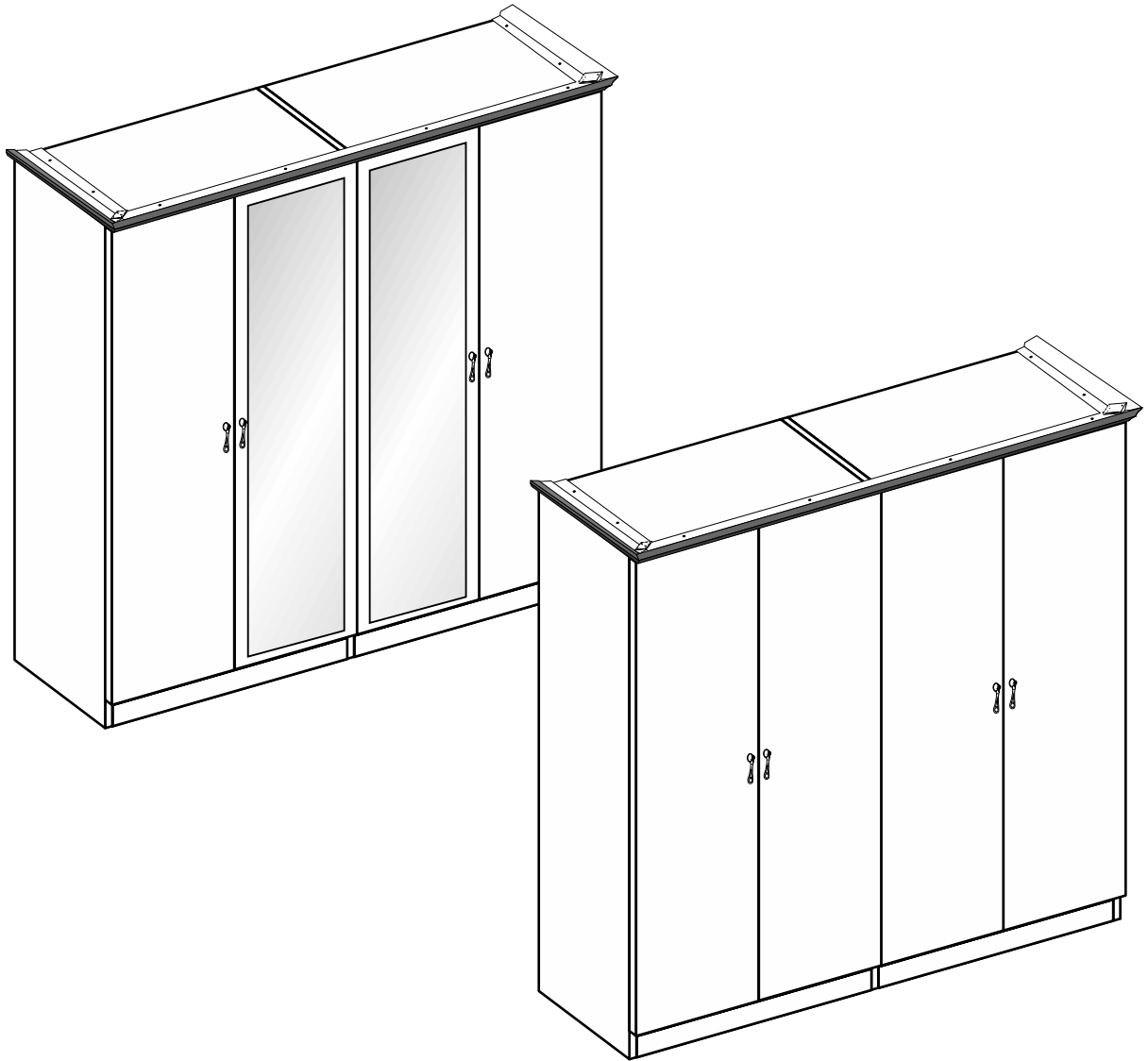

T0041

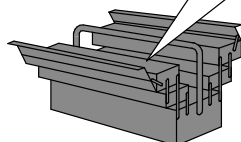
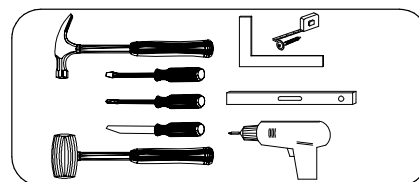
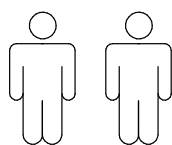

1

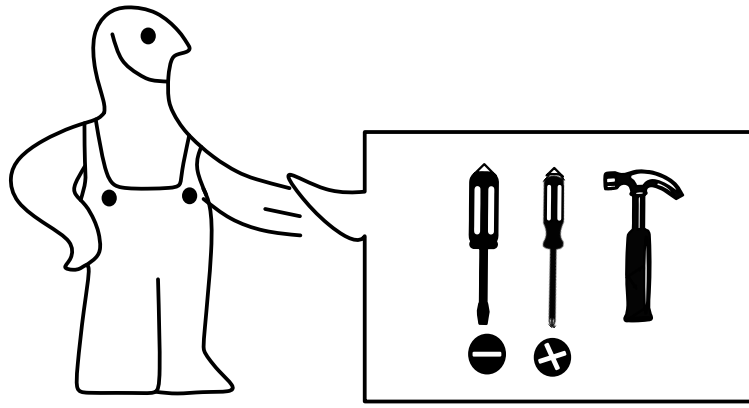

2

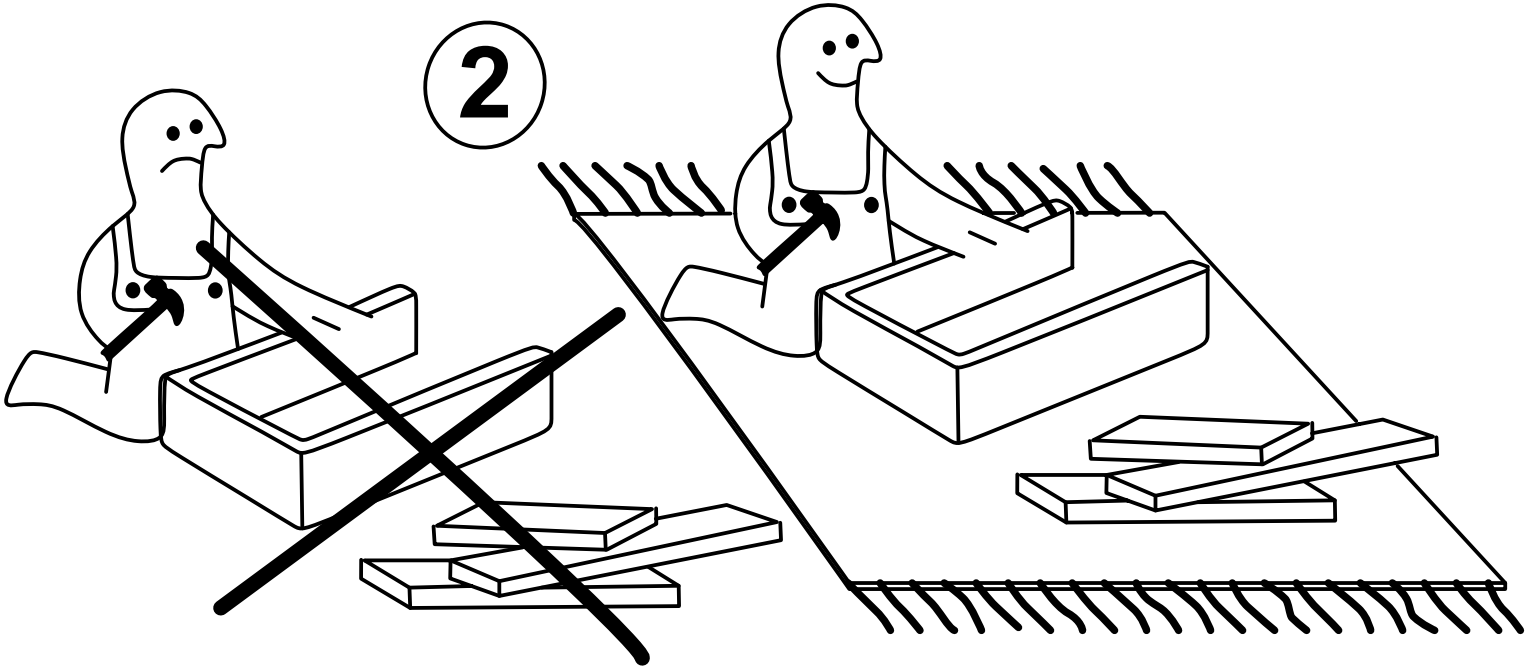

3

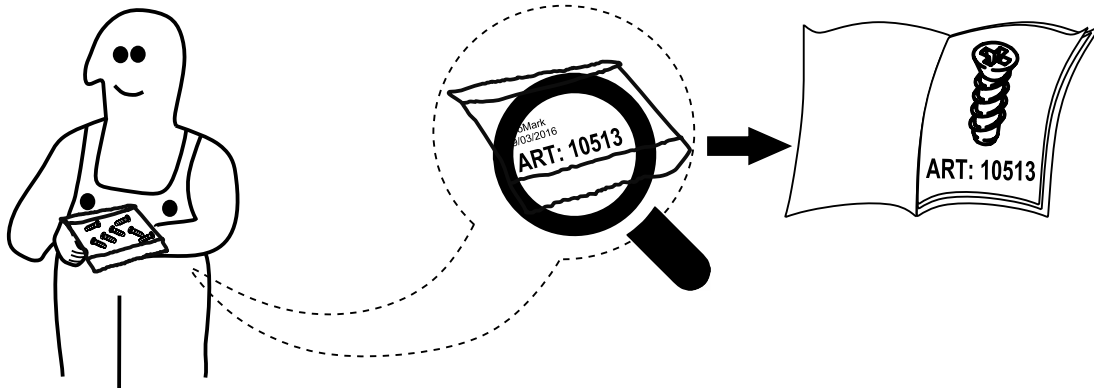

4



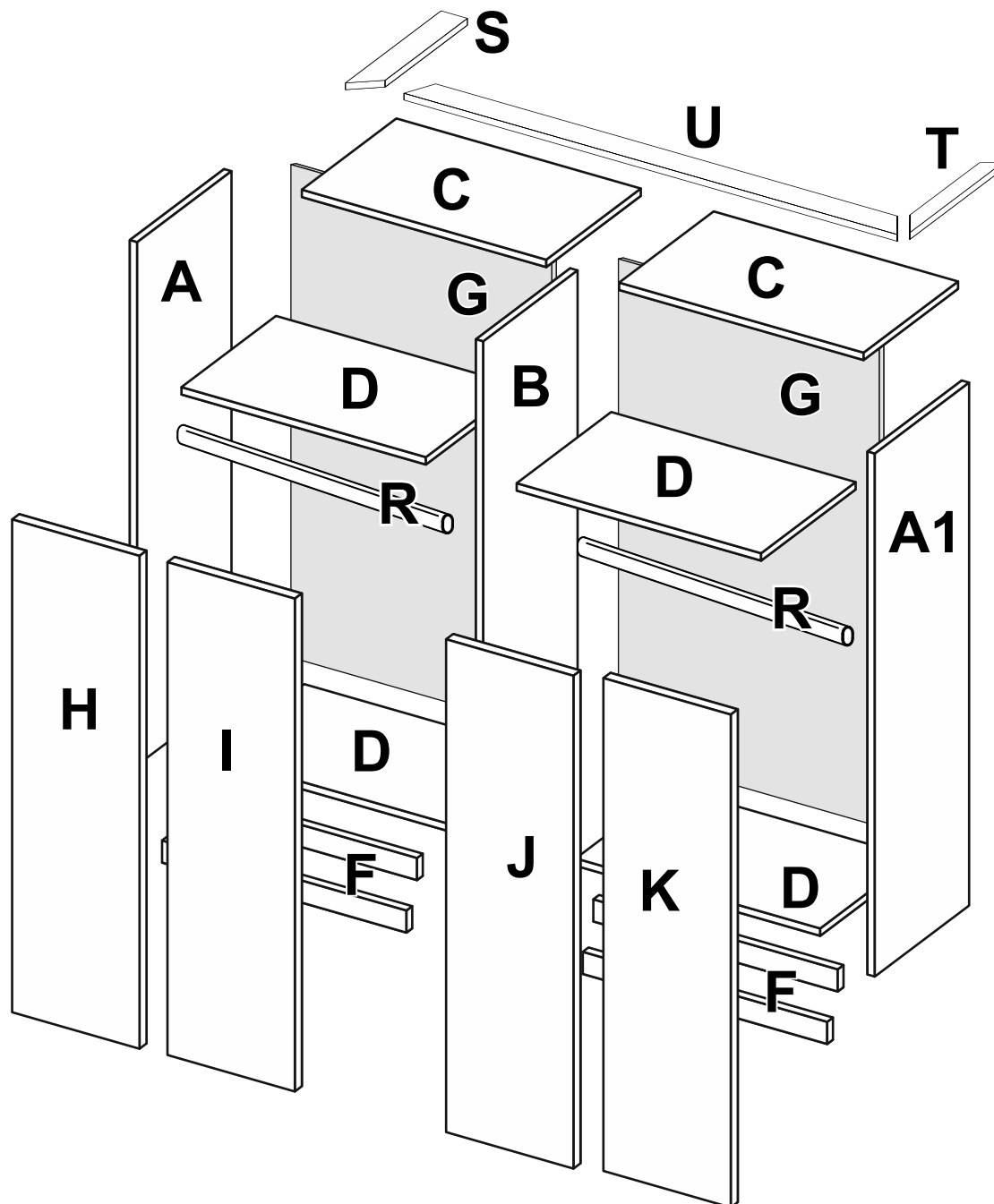

**A** - 2102 x 530 x 16 - **x 1**  
**A1** - 2102 x 530 x 16 - **x 1**  
**B** - 2102 x 516 x 16 - **x 1**  
**C** - 870 x 516 x 16 - **x 4**  
**D** - 870 x 516 x 16 - **x 2**  
**F** - 870 x 50 x 16 - **x 4**  
**G** - 2052 x 883 x 3 - **x 2**  
**H** - 2050 x 444 x 16 - **x 1**

**I** - 2050 x 444 x 16 - **x 1**  
**J** - 2050 x 444 x 16 - **x 1**  
**K** - 2050 x 444 x 16 - **x 1**  
**R** - 862 - **x 2**  
**S** - 596 x 97 x 25 - **x 1**  
**T** - 596 x 97 x 25 - **x 1**  
**U** - 1894 x 97 x 25 - **x 1**

